



# SELF-PRIMING CENTRIFUGAL PUMPS

**MANUAL  
PART 1 of 3**

# INSTALLATION AND OPERATION

**THE GORMAN-RUPP COMPANY • MANSFIELD, OHIO**

GORMAN-RUPP OF CANADA LIMITED • ST. THOMAS, ONTARIO, CANADA Printed in U.S.A.

©Copyright by the Gorman-Rupp Company

## INTRODUCTION

**Thank You** for purchasing a Gorman-Rupp Self-Priming Centrifugal Pump. **Read this manual** carefully to learn how to safely install and operate your pump. Failure to do so could result in personal injury or damage to the pump.

A set of three manuals accompanies your pump. Each set consists of three parts; the Installation/Operation Manual contains essential information on installing and operating the pumps. However, since pump installations are seldom identical, some of the information only summarizes general recommendations and practices required to inspect, position, and arrange the pump and piping.

The Parts List Manual provides performance curve(s), a pump model cross-section drawing, and parts list for your pump.

The Maintenance and Repair Manual provides troubleshooting and maintenance instructions required to properly diagnose operational problems, and to service the pump components.

Because pump installations are seldom identical, this manual cannot possibly provide detailed in-

structions and precautions for every aspect of each specific application. Therefore, it is the responsibility of the owner/installer of the pump to ensure that applications not addressed in this manual are performed **only** after establishing that neither operator safety nor pump integrity are compromised by the installation. Pumps and related equipment **must** be installed and operated according to all national, local and industry standards.

If there are any questions regarding the pump which are not covered in this manual or in other literature accompanying the unit, please contact your Gorman-Rupp distributor or the Gorman-Rupp Company:

**The Gorman-Rupp Company**  
**P.O. Box 1217**  
**Mansfield, Ohio 44901--1217**  
 or:  
**Gorman-Rupp of Canada Limited**  
**70 Burwell Road**  
**St. Thomas, Ontario N5P 3R7**

## CONTENTS

### SAFETY -- SECTION A

#### INSTALLATION -- SECTION B

GENERAL INFORMATION .....	PAGE B – 1
PREINSTALLATION INSPECTION .....	PAGE B – 1
POSITIONING PUMP .....	PAGE B – 1
SUCTION AND DISCHARGE PIPING .....	PAGE B – 2
AUTOMATIC AIR RELEASE VALVE .....	PAGE B – 5
ALIGNMENT .....	PAGE B – 7
ELECTRICAL CONNECTIONS .....	PAGE B – 9

#### OPERATION -- SECTION C

PRIMING .....	PAGE C – 1
STARTING .....	PAGE C – 1
OPERATION .....	PAGE C – 2
STOPPING .....	PAGE C – 3
BEARING TEMPERATURE CHECK .....	PAGE C – 4
LUBRICATION .....	PAGE C – 4

## RECORDING MODEL AND SERIAL NUMBERS

Please record the pump model and serial number in the spaces provided below. Your Gorman-Rupp distributor needs this information when you require parts or service.

Pump Model: \_\_\_\_\_

Serial Number: \_\_\_\_\_

The following are used to alert personnel to procedures which require special attention, to those which could damage equipment, and to those which could be dangerous to personnel:



**Immediate hazards which WILL result in severe personal injury or death. These instructions describe the procedure required and the injury which will result from failure to follow the procedure.**



**Hazards or unsafe practices which COULD result in severe personal injury or death. These instructions describe the procedure required and the injury which could result from failure to follow the procedure.**

## WARRANTY INFORMATION

The warranty provided with your pump is part of Gorman-Rupp's support program for customers who operate and maintain their equipment as described in this and the other accompanying literature. Please note that should the equipment be abused or modified to change its performance beyond the original factory specifications, the warranty will become void and any claim will be denied.



Hazards or unsafe practices which COULD result in minor personal injury or product or property damage. These instructions describe the requirements and the possible damage which could result from failure to follow the procedure.

### NOTE

*Instructions to aid in installation, operation, and maintenance or which clarify a procedure.*

---

## SAFETY - SECTION A

This information applies to G-R Self-Priming Centrifugal pumps. These pumps are available as basic, pedestal-mounted models or as close-coupled models driven by either an electric motor, gasoline or diesel engine. Refer to the manual accompanying the power source before attempting to begin operation.

This manual will alert personnel to known procedures which require special attention, to those which could damage equipment, and to those which could be dangerous to personnel. However, this manual cannot possibly anticipate and provide detailed instructions and precautions for every situation that might occur during maintenance of the unit. Therefore, it is the responsibility of the owner/maintenance personnel to ensure that only safe, established maintenance procedures are used, and that any procedures not addressed in this manual are performed only after establishing that neither personal safety nor pump integrity are compromised by such practices.

In addition to this manual, see the separate literature covering maintenance and repair, pump parts, and any optional equipment shipped with the pump.



Before attempting to open or service the pump:

1. Familiarize yourself with this manual.
2. Disconnect or shut down the power source and take necessary precautions to ensure that the pump will remain inoperative.
3. Allow the pump to completely cool if overheated.

4. Check the temperature before opening any covers, plates, or plugs.
5. Close the suction and discharge valves.
6. Vent the pump slowly and cautiously.
7. Drain the pump.



Do not attempt to pump any liquids the pump has not been designed for, and which may damage the pump or endanger personnel as a result of pump failure. Consult the factory to determine compatibility between the pump and liquid.



Use lifting and moving equipment in good repair and with adequate capacity to prevent injuries to personnel or damage to equipment. Suction and discharge hoses and piping must be removed from the pump before lifting.



After the pump has been positioned, make certain that the pump and all piping or hose connections are tight, properly supported and secure before operation.



Do not operate the pump against a closed discharge valve for long periods of time. If operated against a closed discharge valve, pump components will deteriorate, and the liquid could come

to a boil, build pressure, and cause the pump casing to rupture or explode.



Do not remove plates, covers, gauges, pipe plugs, or fittings from an overheated pump. Vapor pressure within the pump can cause parts being disengaged to be ejected with great force. Allow the pump to cool before servicing.



These pumps may be used to handle products which if overheated could produce dangerous fumes. Use extreme caution when venting the pump, or when removing covers, plates, plugs, or fittings.



Never run this pump backwards. Be certain that rotation is correct before fully engaging the pump.



If the pump is used to pump materials which could cause serious illness or injury through direct exposure or emitted fumes, wear protective clothing, such as rubber gloves, face mask, and rubber apron, as necessary before disassembling the pump or piping.



Do not operate the pump without shields and/or guards in place over the drive shafts, belts, and/or couplings, or other rotating parts. Exposed rotating

parts can catch clothing, fingers, or tools, causing severe injury to personnel.



If the pump is powered by an electric motor, do not operate a non-explosion proof motor in an explosive atmosphere. An explosion, which may cause severe personal injury or death, could result. Install, connect and operate the motor in accordance with the National Electric Code and all local codes. If there is a conflict between the instructions in the manual accompanying the unit and the National Electric Code or applicable local code, the National or Local code shall take precedence. All electrical equipment supplied with the pump conforms to applicable federal regulations and national codes in effect on the date of manufacture.



If the pump is electric motor driven, the electrical power used to operate this pump is high enough to cause injury or death. Obtain the services of a qualified electrician to troubleshoot, test and/or service the electrical components of this pump.



If the pump is powered by an internal combustion engine, do not operate in an explosive atmosphere. When operating internal combustion engines in an enclosed area, make certain that exhaust fumes are piped to the outside. These fumes contain carbon monoxide, a deadly gas that is colorless, tasteless, and odorless.

**WARNING!**

Fuel used by internal combustion engines presents an extreme explosion and fire hazard. Make certain that all fuel lines are securely connected and free of leaks. Never refuel a hot or running engine. Avoid overfilling the fuel tank. Always use the correct type of fuel.

**WARNING!**

Never tamper with the engine governor to gain more power. The governor establishes safe operating limits that should not be exceeded. The maximum contin-

uous operating speed for the pump is shown on the performance curve (see the Parts List Manual).

**WARNING!**

If the pump is powered by an engine, the engine exhaust from this product contains chemicals known to the State of California to cause cancer, birth defects or other reproductive harm.

**CAUTION**

Pumps and related equipment must be installed and operated according to all national, local and industry standards.

## INSTALLATION – SECTION B

### Review all SAFETY information in Section A.

Since pump installations are seldom identical, this section offers only general recommendations and practices required to inspect, position, and arrange the pump and piping.

Most of the information pertains to a standard **static lift** application where the pump is positioned above the free level of liquid to be pumped.

If installed in a **flooded suction application** where the liquid is supplied to the pump under pressure, some of the information such as mounting, line configuration, and priming must be tailored to the specific application. Since the pressure supplied to the pump is critical to performance and safety, **be sure** to limit the incoming pressure to 50% of the maximum permissible operating pressure as shown on the pump performance curve (see Parts List Manual). **If the pump is fitted with a Gorman-Rupp double grease lubricated seal, the maximum incoming pressure must be reduced to 10 p.s.i.**

For further assistance, contact your Gorman-Rupp distributor or the Gorman-Rupp Company.

### PREINSTALLATION INSPECTION

The pump assembly was inspected and tested before shipment from the factory. Before installation, inspect the pump for damage which may have occurred during shipment. Check as follows:

- a. Inspect the pump and power source (if so equipped) for cracks, dents, damaged threads, and other obvious damage.
- b. Check for and tighten loose attaching hardware. Since gaskets tend to shrink after drying, check for loose hardware at mating surfaces.
- c. Carefully read all tags, decals, and markings on the pump assembly, and perform all duties indicated. Note that the pump shaft rotates in the required direction.
- d. Check levels and lubricate as necessary. Refer to **LUBRICATION** in the **MAINTENANCE AND REPAIR** section of this manual and any other literature accompanying the unit and perform duties as instructed.
- e. If the pump and power source have been stored for more than 12 months, some of the components or lubricants may have exceeded their maximum shelf life. These **must be inspected or replaced** to ensure maximum pump service.

If the maximum shelf life has been exceeded, or if anything appears to be abnormal, contact your Gorman-Rupp distributor or the factory to determine the repair or updating policy. **Do not** put the pump into service until appropriate action has been taken.

### Battery Installation

If the pump is engine driven, the engine battery is **not** included with the unit unless otherwise specified on the pump order. See the battery tag included with the battery box assembly for battery specifications. Refer to information accompanying the battery and/or electrolyte solution for activation and charging instructions.

Before installing the battery, clean the positive and negative cable connectors, and the battery terminals. Secure the battery by tightening the hold-down brackets. The terminals and clamps may be coated with petroleum jelly to retard corrosion. Connect and tighten the positive cable first, then the negative cable.

### POSITIONING PUMP

#### Lifting

Use lifting equipment with a capacity of at least **5 times** the weight of the pump, not including the weight of accessories, wheel kit or optional equipment. Customer installed equipment such as suction and discharge piping **must** be removed before attempting to lift.



The pump assembly can be seriously damaged if the chains or cables used to lift and move the unit are improperly wrapped around the pump.

### Mounting

Locate the pump in an accessible place as close as practical to the liquid being pumped. Level mounting is essential for proper operation.

The pump may have to be supported or shimmed to provide for level operation or to eliminate vibration.

If the pump has been mounted on a moveable base, make certain the base is stationary by setting the brake and blocking the wheels before attempting to operate the pump.

If the pump is engine driven, **do not** position the pump and engine more than 15° off horizontal for continuous operation in order to ensure sufficient lubrication and fuel supply to the engine. The pump and engine may be positioned up to 30° off horizontal for **intermittent operation only**; however, the engine manufacturer should be consulted for continuous operation at angles greater than 15°.

### Clearance

When positioning the pump, allow clearance in front of the back cover to permit removal of the cover and easy access to the pump interior. Consult the factory or the Specification Data sheet for recommended clearance.

## SUCTION AND DISCHARGE PIPING

Pump performance is adversely effected by increased suction lift, discharge elevation, and friction losses. See the performance curve in the Parts List manual to be sure your overall application allows the pump to operate within the safe operation range.

### Materials

Either pipe or hose may be used for suction and discharge lines; however, the materials must be compatible with the liquid being pumped. If hose is used in suction lines, it must be the rigid-wall, reinforced type to prevent collapse under suction. Using piping couplings in suction lines is not recommended.

### Line Configuration

Keep suction and discharge lines as straight as possible to minimize friction losses. Make minimum use of elbows and fittings, which substantially increase friction loss. If elbows are necessary, use the long-radius type to minimize friction loss.

### Connections to Pump

Before tightening a connecting flange, align it exactly with the pump port. Never pull a pipe line into place by tightening the flange bolts and/or couplings.

Lines near the pump must be independently supported to avoid strain on the pump which could cause excessive vibration, decreased bearing life, and increased shaft and seal wear. If hose-type lines are used, they should have adequate support to secure them when filled with liquid and under pressure.

### Gauges

Most pumps are drilled and tapped for installing discharge pressure and vacuum suction gauges. If these gauges are desired for pumps that are not tapped, drill and tap the suction and discharge lines not less than 18 inches (457,2 mm) from the suction and discharge ports and install the lines. Installation closer to the pump may result in erratic readings.

## SUCTION LINES

To avoid air pockets which could affect pump priming, the suction line must be as short and direct as possible. When operation involves a suction lift, the line must always slope upward to the pump from the source of the liquid being pumped; if the line



slopes down to the pump at any point along the suction run, air pockets will be created.

### Fittings

Suction lines should be the same size as the pump inlet. If reducers are used in suction lines, they should be the eccentric type, and should be installed with the flat part of the reducers uppermost to avoid creating air pockets. Valves are not normally used in suction lines, but if a valve is used, install it with the stem horizontal to avoid air pockets.

### Strainers

If a strainer is furnished with the pump, be certain to use it; any spherical solids which pass through a strainer furnished with the pump will also pass through the pump itself.

If a strainer is not furnished with the pump, but is installed by the pump user, make certain that the total area of the openings in the strainer is at least three or four times the cross section of the suction line, and that the openings will not permit passage of solids larger than the solids handling capability of the pump.

Refer to the Specification Data sheet for the spherical solids handling capability of your specific pump model.

### Sealing

Since even a slight leak will affect priming, head, and capacity, especially when operating with a high suction lift, all connections in the suction line should be sealed with pipe dope to ensure an airtight seal. Follow the sealant manufacturer's recommendations when selecting and applying the pipe dope. The pipe dope should be compatible with the liquid being pumped.

### Suction Lines In Sumps

If a single suction line is installed in a sump, it should be positioned away from the wall of the sump at a distance equal to 1-1/2 times the diameter of the suction line.

If there is a liquid flow from an open pipe into the sump, the flow should be kept away from the suction inlet because the inflow will carry air down into the sump, and air entering the suction line will reduce pump efficiency.

If it is necessary to position inflow close to the suction inlet, install a baffle between the inflow and the suction inlet at a distance 1-1/2 times the diameter of the suction pipe. The baffle will allow entrained air to escape from the liquid before it is drawn into the suction inlet.

If two suction lines are installed in a single sump, the flow paths may interact, reducing the efficiency of one or both pumps. To avoid this, position the suction inlets so that they are separated by a distance equal to at least 3 times the diameter of the suction pipe.

### Suction Line Positioning

The depth of submergence of the suction line is critical to efficient pump operation. Figure 1 shows recommended minimum submergence vs. velocity.

#### NOTE

*The pipe submergence required may be reduced by installing a standard pipe increaser fitting at the end of the suction line. The larger opening size will reduce the inlet velocity. Calculate the required submergence using the following formula based on the increased opening size (area or diameter).*

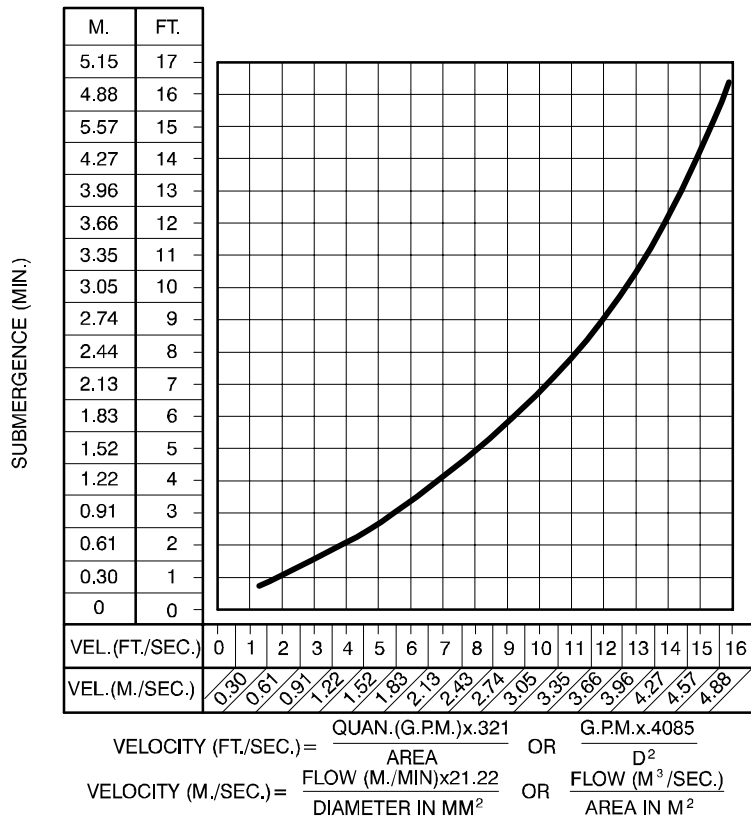

Figure 1. Recommended Minimum Suction Line Submergence vs. Velocity

**DISCHARGE LINES**

**Siphoning**

Do not terminate the discharge line at a level lower than that of the liquid being pumped unless a siphon breaker is used in the line. Otherwise, a siphoning action causing damage to the pump could result.

**Valves**

If a throttling valve is desired in the discharge line, use a valve as large as the largest pipe to minimize friction losses. Never install a throttling valve in a suction line.

A check valve in the discharge line is normally recommended, but it is not necessary in low discharge head applications.

With high discharge heads, it is recommended that a throttling valve and a system check valve be installed in the discharge line to protect the pump from excessive shock pressure and reverse rotation when it is stopped.

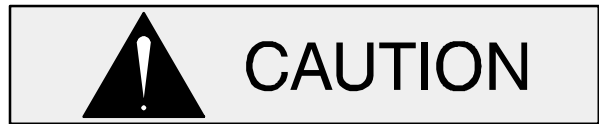

If the application involves a high discharge head, gradually close the discharge throttling valve before stopping the pump.

**Bypass Lines**

Self-priming pumps are not air compressors. During the priming cycle, air from the suction line must be vented to atmosphere on the discharge side. If the discharge line is open, this air will be vented through the discharge. However, if a check valve has been installed in the discharge line, the discharge side of the pump must be opened to atmospheric pressure through a bypass line installed between the pump discharge and the check valve. A self-priming centrifugal pump **will not prime** if there is sufficient static liquid head to hold the discharge check valve closed.

**NOTE**

*The bypass line should be sized so that it does not affect pump discharge capacity; however, the bypass line should be at least 1 inch in diameter to*

*minimize the chance of plugging.*

In **low discharge head applications** (less than 30 feet or 9 meters), it is recommended that the bypass line be run back to the wet well, and located 6 inches below the water level or cut-off point of the low level pump. In some installations, this bypass line may be terminated with a six-to-eight foot length of 1 1/4 inch I.D. **smooth-bore** hose; air and liquid vented during the priming process will then agitate the hose and break up any solids, grease, or other substances likely to cause clogging.



A bypass line that is returned to a wet well must be secured against being drawn into the pump suction inlet.

It is also recommended that pipe unions be installed at each 90° elbow in a bypass line to ease disassembly and maintenance.

In **high discharge head applications** (more than 30 feet), an excessive amount of liquid may be bypassed and forced back to the wet well under the full working pressure of the pump; this will reduce overall pumping efficiency. **Therefore, it is recommended that a Gorman-Rupp Automatic Air Release Valve be installed in the bypass line.**

Gorman-Rupp Automatic Air Release Valves are reliable, and require minimum maintenance. See **AUTOMATIC AIR RELEASE VALVE** in this section for installation and theory of operation of the Automatic Air Release Valve. Consult your Gorman-Rupp distributor, or contact the Gorman-Rupp Company for selection of an Automatic Air Release Valve to fit your application.

If the installation involves a flooded suction such as a below-ground lift station, a pipe union and manual shut-off valve may be installed in the bleed line to allow service of the valve without shutting down the station, and to eliminate the possibility of flooding. If a manual shut-off valve is installed **anywhere** in

the air release piping, it **must** be a full-opening **ball type** valve to prevent plugging by solids.



**If a manual shut-off valve is installed in a bypass line, it must not be left closed during operation. A closed manual shut-off valve may cause a pump which has lost prime to continue to operate without reaching prime, causing dangerous overheating and possible explosive rupture of the pump casing. Personnel could be severely injured.**

**Allow an over-heated pump to cool before servicing. Do not remove plates, covers, gauges, or fittings from an over-heated pump. Liquid within the pump can reach boiling temperatures, and vapor pressure within the pump can cause parts being disengaged to be ejected with great force. After the pump cools, drain the liquid from the pump by removing the casing drain plug. Use caution when removing the plug to prevent injury to personnel from hot liquid.**

## AUTOMATIC AIR RELEASE VALVE

When properly installed and correctly adjusted to the specific hydraulic operating conditions of the application, the Gorman-Rupp Automatic Air Release Valve will permit air to escape through the bypass line, and then close automatically when the pump is fully primed and pumping at full capacity.

### Theory of Operation

Figures 2 and 3 show a cross-sectional view of the Automatic Air Release Valve, and a corresponding description of operation.

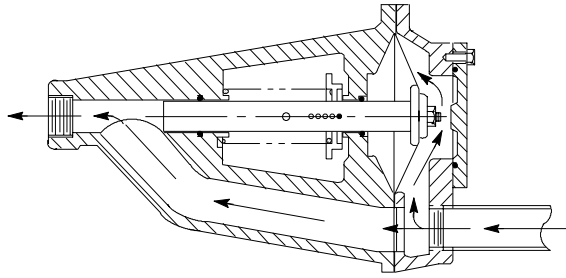

Figure 2. Valve in Open Position

During the priming cycle, air from the pump casing flows through the bypass line, and passes through the Air Release Valve to the wet well (Figure 2).

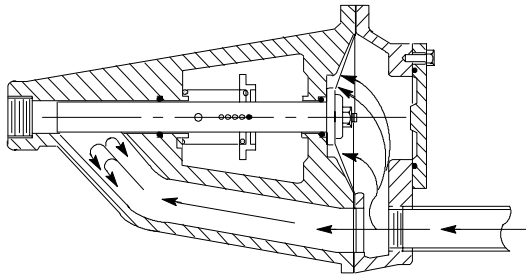

Figure 3. Valve in Closed Position

When the pump is fully primed, pressure resulting from flow against the valve diaphragm compresses the spring and closes the valve (Figure 3). The valve will remain closed, reducing the bypass of liquid to 1 to 5 gallons (3.8 to 19 liters) per minute, until the pump loses its prime or stops.



Some leakage (1 to 5 gallons or 3.8 to 19

liters per minute) will occur when the valve is fully closed. **Be sure the bypass line is directed back to the wet well or tank to prevent hazardous spills.**

When the pump shuts down, the spring returns the diaphragm to its original position. Any solids that may have accumulated in the diaphragm chamber settle to the bottom and are flushed out during the next priming cycle.

**NOTE**

*The valve will remain open if the pump does not reach its designed capacity or head. Valve closing pressure is dependent upon the discharge head of the pump at full capacity. The range of the valve closing pressure is established by the tension rate of the spring as ordered from the factory. Valve closing pressure can be further adjusted to the exact system requirements by moving the spring retaining pin up or down the plunger rod to increase or decrease tension on the spring. Contact your Gorman-Rupp distributor or the Gorman-Rupp Company for information about an Automatic Air Release Valve for your specific application.*

**Air Release Valve Installation**

The Automatic Air Release Valve must be independently mounted in a horizontal position and connected to the discharge line of the self-priming centrifugal pump (see Figure 4).

**NOTE**

*If the Air Release Valve is to be installed on a **staged** pump application, contact the factory for specific installation instructions.*

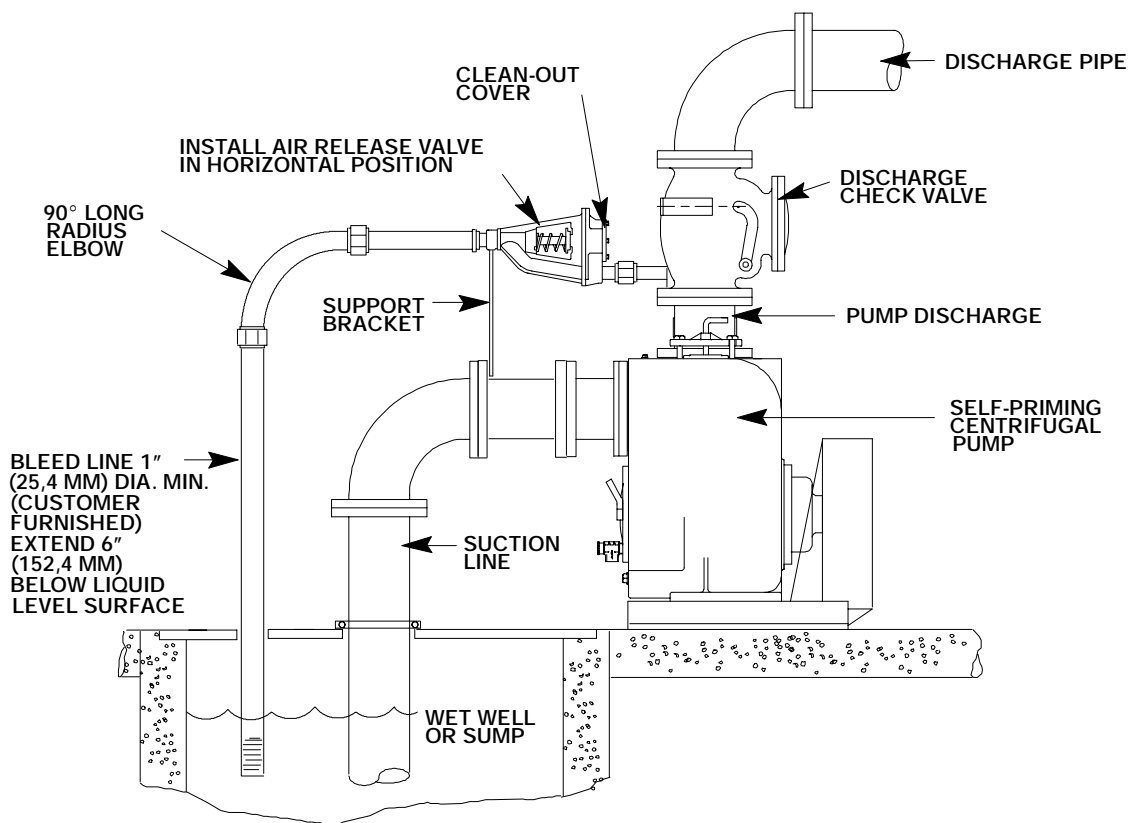

Figure 4. Typical Automatic Air Release Valve Installation

The valve inlet line must be installed between the pump discharge port and the non-pressurized side of the discharge check valve. The valve inlet is at the large end of the valve body, and is provided with standard 1-inch NPT pipe threads.

The valve outlet is located at the opposite end of the valve, and is also equipped with standard 1-inch NPT pipe threads. The outlet should be connected to a bleed line which slopes back to the wet well or sump. The bleed line must be the same size as the inlet piping, or larger. If **pipng** is used for the bleed line, avoid the use of elbows whenever possible.

**NOTE**

*It is recommended that each Air Release Valve be fitted with an independent bleeder line directed back to the wet well. If multiple Air Release Valves are installed in a system, they **must** be fitted with independent bleeder lines; **never** use a common manifold pipe. Contact your Gorman-Rupp distributor or the Gorman-Rupp Company for information about installation of an Automatic Air Release Valve for your specific application.*

**ALIGNMENT**

The alignment of the pump and its power source is critical for trouble-free mechanical operation. In either a flexible coupling or V-belt driven system, the driver and pump must be mounted so that their shafts are aligned with and parallel to each other. It is imperative that alignment be checked after the pump and piping are installed, and before operation.

**NOTE**

*Check **Rotation**, Section C, before final alignment of the pump.*

When mounted at the Gorman-Rupp factory, driver and pump are aligned before shipment. Misalignment will occur in transit and handling. Pumps **must** be checked and realigned before operation. Before checking alignment, tighten the foundation bolts. The pump casing feet and/or pedestal feet, and the driver mounting bolts should also be tightly secured.



When checking alignment, disconnect the power source to ensure that the pump will remain inoperative.



Adjusting the alignment in one direction may alter the alignment in another direction. Check each procedure after altering alignment.

**Coupled Drives**

When using couplings, the axis of the power source must be aligned to the axis of the pump shaft in both the horizontal and vertical planes. Most couplings require a specific gap or clearance between the driving and the driven shafts. Refer to the coupling manufacturer's service literature.

Align spider insert type couplings by using calipers to measure the dimensions on the circumference of the outer ends of the coupling hub every 90 degrees. The coupling is in alignment when the hub ends are the same distance apart at all points (see Figure 5).

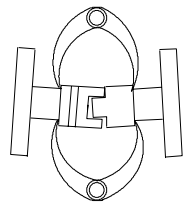

**Figure 5. Aligning Spider-Type Couplings**

Align non-spider type couplings by using a feeler gauge or taper gauge between the coupling halves every 90 degrees. The coupling is in alignment when the hubs are the same distance apart at all points (see Figure 6).

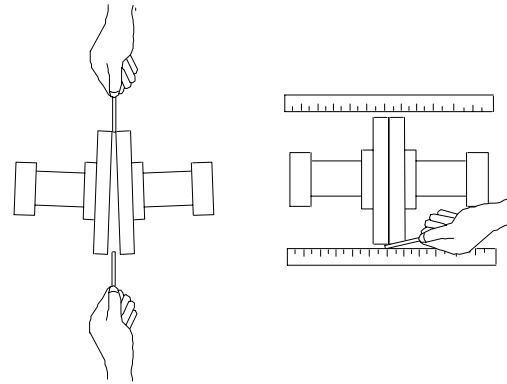
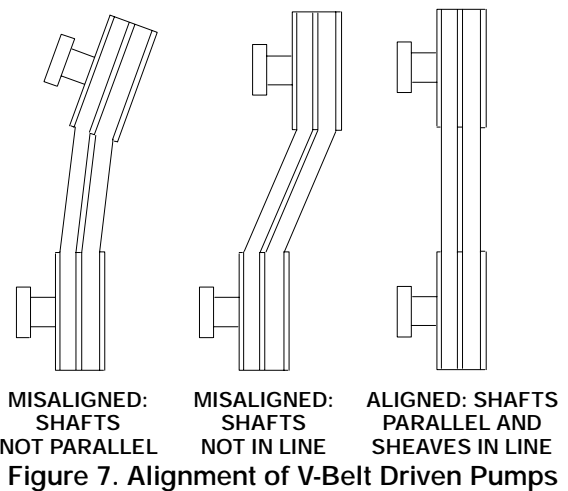

**Figure 6. Aligning Non-Spider Type Couplings**

Check parallel adjustment by laying a straightedge across both coupling rims at the top, bottom, and side. When the straightedge rests evenly on both halves of the coupling, the coupling is in horizontal parallel alignment. If the coupling is misaligned, use a feeler gauge between the coupling and the straightedge to measure the amount of misalignment.

**V-Belt Drives**

When using V-belt drives, the power source and the pump must be parallel. Use a straightedge along the sides of the pulleys to ensure that the pulleys are properly aligned (see Figure 7). In drive systems using two or more belts, make certain that the belts are a matched set; unmatched sets will cause accelerated belt wear.



Tighten the belts in accordance with the belt manufacturer's instructions. If the belts are too loose, they will slip; if the belts are too tight, there will be excessive power loss and possible bearing failure.

Select pulleys that will match the proper speed ratio; overspeeding the pump may damage both pump and power source.



Do not operate the pump without the guard in place over the rotating parts. exposed rotating parts can catch clothing, fingers, or tools, causing severe injury to personnel.

## ELECTRICAL CONNECTIONS

If the pump is driven by an electric motor, check that the electrical service available matches the motor requirements stamped on the motor nameplate before connecting a motor to the incoming power. Check that the motor speed meets pump specifications.

If rotation is incorrect on a three-phase motor, have a qualified electrician interchange any two of the three phase wires to change direction. If rotation is incorrect on a single-phase motor, consult the literature supplied with the motor for specific instructions.



The electrical power used to operate the pump is high enough to cause injury or death. Obtain the services of a qualified electrician to make all electrical connections.



If the pump is powered by an electric motor, do not operate a non-explosion proof motor in an explosive atmosphere. An explosion, which may cause severe personal injury or death, could result. Install, connect and operate the motor in accordance with the National Electric Code and all local codes. If there is a conflict between the instructions in the manual accompanying the unit and the National Electric Code or applicable local code, the National or Local code shall take precedence. All electrical equipment supplied with the pump conforms to applicable federal regulations and national codes in effect on the date of manufacture.

## OPERATION – SECTION C

Review all **SAFETY** information in Section A.

Follow the instructions on all tags, labels and decals attached to the pump.



Do not attempt to pump any liquids the pump has not been designed for, and which may damage the pump or endanger personnel as a result of pump failure.



Pump speed and operating conditions must be within the performance range shown on the curve in Parts Lists manual.

Refer to the pump Specification Data Sheet or the accompanying Parts List Manual for the specific performance for your pump.

### PRIMING

Install the pump and piping as described in **INSTALLATION**. Make sure that the piping connections are tight, and that the pump is securely mounted. Check that the pump is properly lubricated (see **LUBRICATION** in the **MAINTENANCE AND REPAIR** manual).

The pump is self-priming, but it should never be operated unless there is liquid in the pump casing.



Never operate the pump unless there is liquid in the pump casing. The pump will not prime when dry. Extended operation of a dry pump will destroy the seal assembly.

Add liquid to the pump casing when:

1. The pump is being put into service for the first time.
2. The pump has not been used for a considerable length of time.
3. The liquid in the pump casing has evaporated.

Once the pump casing has been filled, the pump will prime and reprime as necessary.



After filling the pump casing, reinstall and tighten the fill plug. Do not attempt to operate the pump unless all connecting piping is securely installed. Otherwise, liquid in the pump forced out under pressure could cause injury to personnel.

To fill the pump, remove the pump casing fill cover or fill plug in the top of the casing, and add clean liquid until the casing is filled. Replace the fill cover or fill plug before operating the pump.

### STARTING

Starting procedures will vary slightly depending on the pump application, type of priming device, and type of drive. Consult the operations manual furnished with the power source.

#### Rotation

The correct direction of pump rotation is indicated by an arrow on the pump body or accompanying decals. If the pump is operated in the wrong direction, the impeller could become loosened from the shaft and seriously damage the pump.

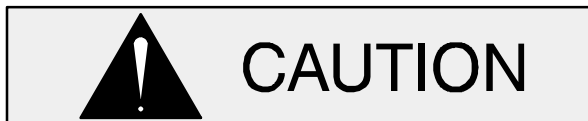

The pump must operate in the direction indicated by the arrow on the pump, or ac-



companying decals. Reverse rotation could loosen the impeller and seriously damage the pump.

If the pump is driven by an electric motor, consult the operating manual furnished with the motor before attempting to start the motor.

If rotation is incorrect on a three-phase motor, have a qualified electrician interchange any two of the three phase wires to change direction. If rotation is incorrect on a single-phase motor, consult the literature supplied with the motor for specific instructions.

## OPERATION



Pump speed and operating points must be within the continuous performance range shown on the pump curve. (See the Parts List Manual accompanying the pump.)

### Lines With a Bypass

Close the discharge throttling valve (if so equipped) so that the pump will not have to prime against the weight of the liquid in the discharge line. Air from the suction line will be discharged through the bypass line back to the wet well during the priming cycle. When the pump is fully primed and liquid is flowing steadily from the bypass line, open the discharge throttling valve. Liquid will then continue to circulate through the bypass line while the pump is in operation.

### Lines Without a Bypass

Open all valves in the discharge line and start the power source. Priming is indicated by a positive reading on the discharge pressure gauge or by a quieter operation. The pump may not prime immediately because the suction line must first fill with liquid. If the pump fails to prime within five minutes, stop it and check the suction line for leaks.

After the pump has been primed, partially close the discharge line throttling valve in order to fill the line slowly and guard against excessive shock pres-

sure which could damage pipe ends, gaskets, sprinkler heads, and any other fixtures connected to the line. When the discharge line is completely filled, adjust the throttling valve to the required flow rate.



**Do not operate the pump against a closed discharge throttling valve for long periods of time. If operated against a closed discharge throttling valve, pump components will deteriorate, and the liquid could come to a boil, build pressure, and cause the pump casing to rupture or explode.**

### Leakage

No leakage should be visible at pump mating surfaces, or at pump connections or fittings. Keep all line connections and fittings tight to maintain maximum pump efficiency.

### Liquid Temperature And Overheating

Refer to the Specification Data sheet for the **maximum** liquid temperature for your specific pump. Do not apply the pump at a higher operating temperature.

Overheating can occur if operated with the valves in the suction or discharge lines closed. Operating against closed valves could bring the liquid to a boil, build pressure, and cause the pump to rupture or explode. If overheating occurs, stop the pump and allow it to cool before servicing it. Refill the pump casing with cool liquid.



**Allow an over-heated pump to completely cool before servicing. Do not remove plates, covers, gauges, or fittings from an over-heated pump. Liquid within the pump can reach boiling temperatures, and vapor pressure within the pump can cause parts being disengaged to be ejected with great force. Af-**

**ter the pump cools, drain the liquid from the pump by removing the casing drain plug. Use caution when removing the plug to prevent injury to personnel from hot liquid.**

If overheating does occur, stop the pump immediately and allow it to cool before servicing it. **Approach any overheated pump cautiously.**

As a safeguard against rupture or explosion due to heat, some pumps are equipped with a pressure relief valve which will open if vapor pressure within the pump casing reaches a critical point. It is recommended that the pressure relief valve assembly be replaced at each overhaul, or any time the pump casing overheats and activates the valve. **Never** replace this valve with a substitute which has not been specified or provided by the Gorman-Rupp Company.

#### Strainer Check

If a suction strainer has been shipped with the pump or installed by the user, check the strainer regularly, and clean it as necessary. The strainer should also be checked if pump flow rate begins to drop. If a vacuum suction gauge has been installed, monitor and record the readings regularly to detect strainer blockage.

**Never** introduce air or steam pressure into the pump casing or piping to remove a blockage. This could result in personal injury or damage to the equipment. If backflushing is absolutely necessary, liquid pressure **must** be limited to 50% of the maximum permissible operating pressure shown on the pump performance curve. **If the pump is fitted with a Gorman-Rupp double grease lubricated seal, the maximum incoming pressure must be reduced to 10 p.s.i.**

#### Pump Vacuum Check

With the pump inoperative, install a vacuum gauge in the system, using pipe dope on the threads. Block the suction line and start the pump. At operating speed the pump should pull a vacuum of 20 inches (508 mm) or more of mercury. If it does not,

check for air leaks in the seal, gasket, or discharge valve.

Open the suction line, and read the vacuum gauge with the pump primed and at operation speed. Shut off the pump. The vacuum gauge reading will immediately drop proportionate to static suction lift, and should then stabilize. If the vacuum reading falls off rapidly after stabilization, an air leak exists. Before checking for the source of the leak, check the point of installation of the vacuum gauge.

#### Operational Checks

Check the pump for proper operation when it is first started and periodically thereafter to identify minor problems.

Check the pump for unusual noises or excessive vibration while it is operating. If noise or vibration is excessive, stop the pump and refer to **Troubleshooting** in the Maintenance And Repair Manual for possible causes.

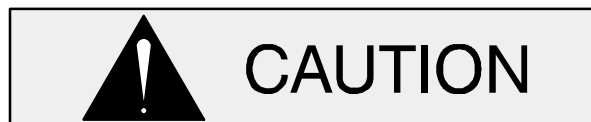

To avoid serious damage to the pump, check for unusual noises or excessive vibration while the pump is running. If noise or vibration is excessive, stop operation and refer to the troubleshooting chart in the Maintenance and Repair manual.

#### STOPPING

Never halt the flow of liquid suddenly. If the liquid being pumped is stopped abruptly, damaging shock waves can be transmitted to the pump and piping system. Close all connecting valves slowly.

On engine driven pumps, reduce the throttle speed slowly and allow the engine to idle briefly before stopping.



If the application involves a high discharge head, gradually close the discharge throttling valve before stopping the pump.

After stopping the pump, lock out or disconnect the power source to ensure that the pump will remain inoperative.

### Cold Weather Preservation

In below freezing conditions, drain the pump to prevent damage from freezing. Also, clean out any solids by flushing with a hose. Operate the pump for approximately one minute; this will remove any remaining liquid that could freeze the pump rotating parts. If the pump will be idle for more than a few hours, or if it has been pumping liquids containing a large amount of solids, drain the pump, and flush it thoroughly with clean water. To prevent large solids from clogging the drain port and preventing the pump from completely draining, insert a rod or stiff wire in the drain port, and agitate the liquid during the draining process. Clean out any remaining solids by flushing with a hose.

## BEARING TEMPERATURE CHECK

Bearings normally run at higher than ambient temperatures because of heat generated by friction. Temperatures up to 160°F (71° C) are considered normal for bearings, and they can operate safely to at least 180°F (82° C).

Checking bearing temperatures by hand is inaccurate. Bearing temperatures can be measured accurately by placing a contact-type thermometer against the housing. Record this temperature for future reference.

A sudden increase in bearing temperature is a warning that the bearings are at the point of failing to operate properly. Make certain that the bearing lubricant is of the proper viscosity and at the correct level (see **LUBRICATION** in the **Maintenance And Repair** manual). Bearing overheating can also be caused by shaft misalignment and/or excessive vibration.

When pumps are first started, the bearings may seem to run at temperatures above normal. Continued operation should bring the temperatures down to normal levels.

## LUBRICATION



**Do not remove plates, covers, gauges, pipe plugs or fittings from an overheated pump. Vapor pressure within the pump can cause parts being disengaged to be ejected with great force. Allow the pump to completely cool before servicing.**

On a new pump, check the oil level in the seal and bearing cavities before initial startup, after the first two weeks of operation, and every month thereafter.

Before installing or removing the lubrication plug, always clean the area around the plug to prevent contamination.

### Self Lubricated Seal Assembly

The self lubricated seal assembly is lubricated by the medium being pumped, or by a flow of fresh liquid from an external source. Flushing liquid may be taken from the pump discharge and supplied through auxiliary piping.

When handling abrasive or tacky liquids, supply fresh lubricating liquid from an external source. Be sure the liquid supplied to the seal is compatible with the liquid being pumped, and that its flow is controlled to prevent dilution. Consult the factory if flushing is required.

### Oil Lubricated Seal Assembly

Before starting the pump, remove the vented plug and fill the seal cavity with SAE No. 30 non-detergent oil. Clean and reinstall the vented plug. Refer to the **Maintenance And Repair** Manual for the seal cavity oil capacity.

### Grease Lubricated Seal Assembly

Fill the automatic grease cup through the grease fitting with No. 2 lithium base grease until grease escapes from the relief hole. Turn the grease cup arm counterclockwise until it is at the top of the

stem; this will release the spring to apply grease to the seal.

### Oil Lubricated Bearings

Bearing housings are fully lubricated when shipped from the factory. Check the oil level regularly and maintain it at the desired level. When lubrication is required, add SAE No. 30 non-detergent oil. **Do not** over-lubricate. Over-lubrication can cause the bearings to over-heat, resulting in premature bearing failure.

Under normal conditions, drain the bearing housing once each year and refill with clean oil. Change the oil more frequently if the pump is operated continuously or installed in an environment with rapid temperature change.



Monitor the condition of the bearing lubricant regularly for evidence of rust or moisture condensation. This is especially important in areas where variable hot and cold temperatures are common.

For cold weather operation, consult the factory or a lubricant supplier for the recommended grade of oil.

### Grease Lubricated Bearings

Bearing housings are fully lubricated when shipped from the factory. Under normal conditions, add No. 0 lithium base grease from a grease gun through the grease fitting after each 250 hours of operation or once each month, whichever comes first. **Do not** over-lubricate. Over-lubrication can cause the bearings to over-heat, resulting in premature bearing failure.

If there is no provision in the bearing cavity to drain or flush the lubricant, the pump and bearing housing must be disassembled to completely clean and maintain this cavity.

Under normal conditions, change the grease after each 5000 hours of operation, or at 12 month intervals, whichever comes first. Change the grease more frequently if the pump is operated continuously or installed in an environment where variable hot and cold temperatures are common.

Refer to the **Maintenance And Repair Manual** for grease capacity of the bearing housing for the pump.

For cold weather operation, consult the factory or a lubricant supplier for the recommended grade of lubricant.

### Power Source

Consult the literature supplied with the power source, or contact your local power source representative.

**For U.S. and International Warranty Information,  
Please Visit [www.grpumps.com/warranty](http://www.grpumps.com/warranty)  
or call:  
U.S.: 419-755-1280  
International: +1-419-755-1352**

**For Canadian Warranty Information,  
Please Visit [www.grcanada.com/warranty](http://www.grcanada.com/warranty)  
or call:  
519-631-2870**